



Handling Precautions for the Nichia UV LEDs

Table of contents

1. Introduction.....	2
2. Storage	2
3. Directions for use.....	3
4. Handling Precautions	4
5. Design Precautions	6
6. Electrostatic Discharge (ESD).....	7
7. Thermal Management	7
8. Cleaning	8
9. Eye Safety	8
10. Others.....	9

1. Introduction

This document provides information about the handling precautions of Nichia LEDs.

2. Storage

Condition		Temperature	Humidity	Time
Storage	Before Opening Aluminum Bag	≤30°C	≤90%RH	Within 1 year from Delivery Date
	After Opening Aluminum Bag	≤30°C	≤70%RH	≤168 hours
Baking		65±5°C	-	≤24 hours

- After opening the moisture-proof aluminum bag, the soldering process should be completed within the time frame mentioned above. Unused remaining LEDs should be stored with desiccants (silica gel) in a hermetically sealed container, preferably in the original moisture-proof bag for storage.
- Upon the expiration of the “Period after Opening Aluminum Bag” or when the silica gel desiccants are no longer blue, the LEDs should be baked. The baking shall be done only once.
- When moisture absorbed in the LED package vaporizes and expands due to the heat generated during the soldering process, the encapsulating resin can be detached from the LED package, resulting in degradation of the optical characteristics. To minimize moisture absorption into the products during transportation and storage, the products are packed in a moisture-proof aluminum bag.

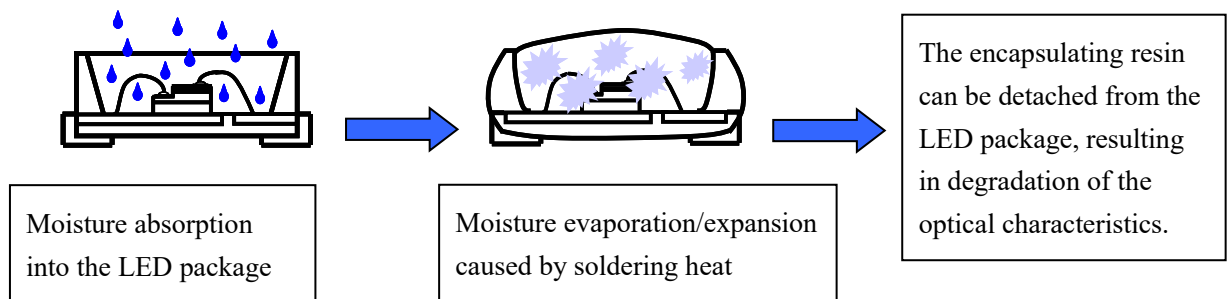

- Keep the LEDs in a hermetically sealed container during storage. When exposed to the atmosphere containing corrosive gas and the like, the property of the plated metal surface can be changed, affecting the solderability and the optical characteristics.
- Refrain from using the materials containing sulfur for gasket, adhesive agents, and so on to avoid the adverse effects on the plating surface.
- A slight amount of corrosive gas can be contained in the articles such as cardboard and rubber, and even in the air. Also, halogen substances, which affect the plating surface, can be contained in the constituents of resin.
- Even after the LEDs are mounted on the board and/or installed in a finished product, the plating surface can be affected by the gas which is volatilized from the surrounding materials or which penetrates into the assembly. Customers should take care in designing the product.
- We recommend that silicone rubber should be used for gasket. Customers should take care not to cause connection failure because of deposited low-molecular siloxane.

- The LEDs must be stored in an environment without significant temperature changes to avoid condensation.
- Do not store the LEDs in a dusty environment.
- Do not expose the LEDs to direct sunlight and/or an environment over a long period of time where the temperature is higher than normal room temperature.

3. Directions for use

- Customers should design the circuit to ensure that each LED is operated within the absolute maximum rating. We recommend that each LED should be operated with a constant current.
- When driving LEDs with a constant voltage, it is recommended to use circuit B. In circuit A, the electrical current through the LEDs may vary due to the variation in the forward voltage applied to each LED.

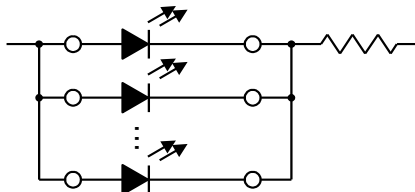

(A) Not Recommended

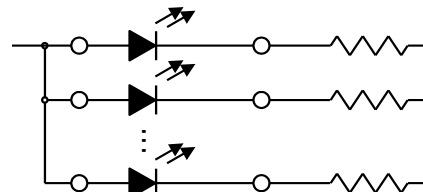

(B) Recommended

- This LED is designed to be operated at a forward current. Ensure that no voltage is applied to the LED in the forward/reverse direction while the LED is off. If the LEDs are used in an environment where reverse voltages are applied to the LED continuously, it may cause electrochemical migration to occur causing the LED to be damaged. When not in use for a long period of time, the system's power should be turned off to ensure that there are no issues/damage.
- To stabilize the LED characteristics while in use, Nichia recommends that the LEDs are operated at currents $\geq 10\%$ of the sorting current.
- Ensure that transient excessive voltages (e.g. lighting surge) are not applied to the LEDs.
- If the LEDs are used for outdoor applications, ensure that necessary measures are taken (e.g. protecting the LEDs from water/salt damage and high humidity).
- Although this LED is specifically designed to emit invisible light, a small amount of light in the visible region exists in the emission spectrum. Ensure that when using the LEDs for sensors, verification is performed to ensure that the emission spectrum is fit for the intended use.
- Exposure to the UV radiation from this LED could cause health risks and degree of hazard may vary depending on the wavelength, irradiance, and exposure time. When necessary, safety and other information/precautions should be provided to the end users. For more details, see Handling Precautions for Ultraviolet Light (UV LEDs). To access the application notes, go to the Technical Suggestions And Recommendations section of Nichia's website.
- The UV light may accelerate the degradation/aging processes of the components used in the chosen system. When selecting a part/material, perform sufficient verification prior to use to ensure that there are no issues, this verification should be performed taking into consideration the conditions/environments in which the end-product containing these LEDs will actually be used. When necessary, safety and other information/precautions should be provided to the end users.

This document contains tentative information, Nichia may change the contents without notice.

- This LED may cause fluorescence to occur resulting in certain devices (e.g. sensors, etc.) failing to function as intended. Taking into consideration the conditions/environments in which the end-product containing these LEDs will actually be used, safety and other information/precautions should be provided to the end users.
- If the UV LEDs are used with LEDs containing a phosphor in the same application, the UV light may cause the phosphor to emit light. The design of the chosen application should ensure that those LEDs are not exposed to the UV light.
- If this product is stored and/or used constantly under high humidity conditions, it may accelerate the deterioration of the die; this may cause the radiant flux to decrease. If the LEDs are stored and/or used under these conditions, sufficient verification must be done prior to use to ensure there are no issues for the chosen application.
- Do not design this LED into applications where condensation may occur. If the LEDs are stored/operated in these environments, it may cause issues (e.g. current leaks that cause the radiant flux to decrease).

4. Handling Precautions

- When handling the product, do not touch the LED with bare hands, since it may contaminate the emitting surface and may affect the optical characteristics. Excessive force on the LED may result in the deformation and/or wire breakage, leading to no light emission.
- When dropped, the LED might be deformed and damaged.

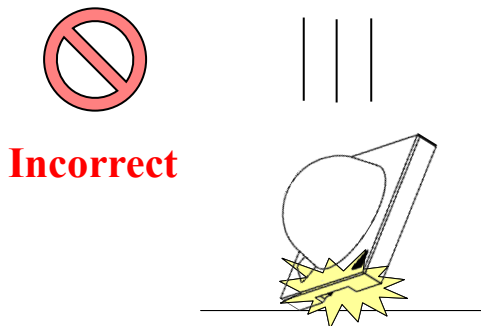

- When using tweezers, prevent excessive stress from being applied to the LEDs. Ensure that when handling the LEDs with tweezers, do not touch the sealing cover/lens on the top of the LED. Otherwise, it may cause damage to the sealing cover/lens (e.g. scratch, chip, crack, delamination, deformation) and the internal connection to fail causing a catastrophic failure (i.e. the LED not to illuminate).

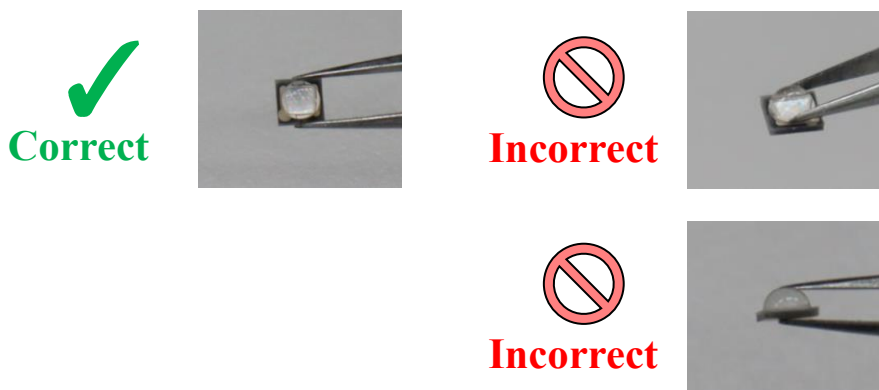

- When picking the LED the suction should be directly above the upper surface of the sealing cover/lens with the suction tweezers.

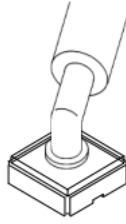

- When using a pick-and-place machine, use a suction nozzle that will not damage the sealing cover/lens.

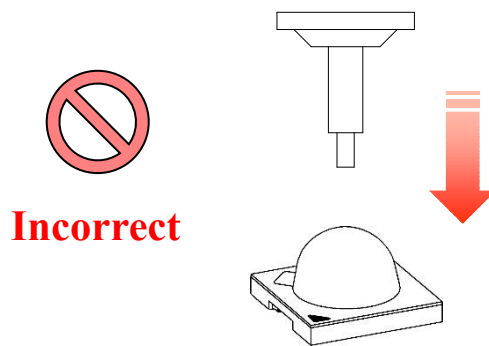

- If a pick-and-place nozzle has a smaller diameter than the LED's emitting surface, it can damage the emitting surface when collecting the LED, resulting in its emission failure. The suitable nozzle should be installed into the assembly machine. Nichia recommends the specific pick-and-place nozzles for some of our products. Customers are requested to refer to Nichia's specifications for the details.

- The LEDs' placing location can vary, when the rotary head mounting machine is used. Customers should evaluate the mounting performance in advance.

- Do not stack assembled PCBs together. Otherwise, the board can damage the sealing cover/lens of the LEDs underneath, resulting in chipping, detachment, deformation, wire breakage, and LED detachment. Consequently, the LED fails to emit light.

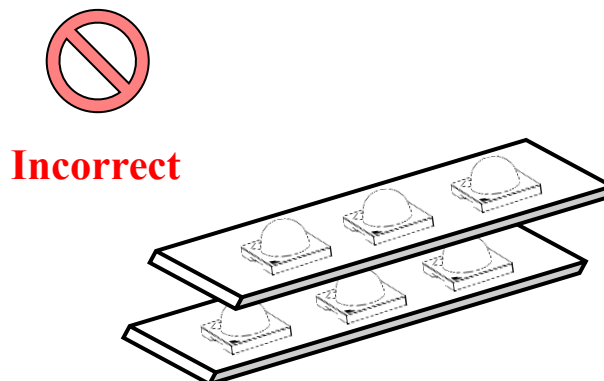

5. Design Precautions

- To operate the LEDs, using a copper-core PCB is recommended; this may cause issues (e.g. cracks in the glass cover/solder joints due to thermal stress) depending on the reflow soldering conditions. Ensure that sufficient verification is performed prior to use to ensure that there are no issues with the PCB/soldering conditions for the chosen application.
- When bending stress is applied to the board with LEDs solder-mounted on, the LED packages can get cracked. Attach the LEDs to the board where they are less exposed to bending/twisting stress.

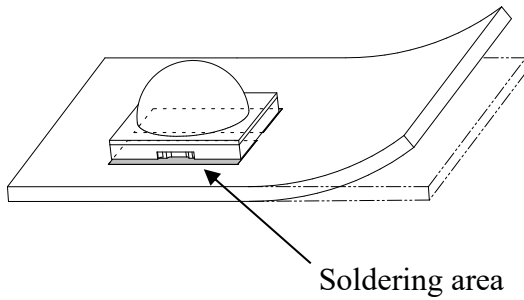

(A) Recommended

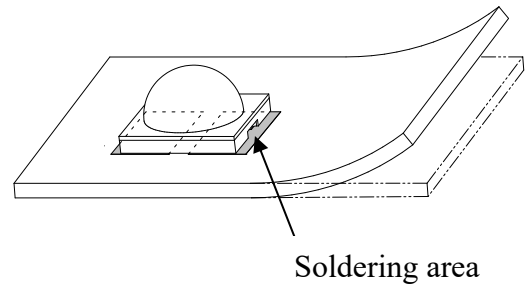

(B) Not good

- Around the separation area of the board, the degree of mechanical stress applied to the LEDs depends on the LED mounting location. The LEDs should be attached where the least stress is applied to them.

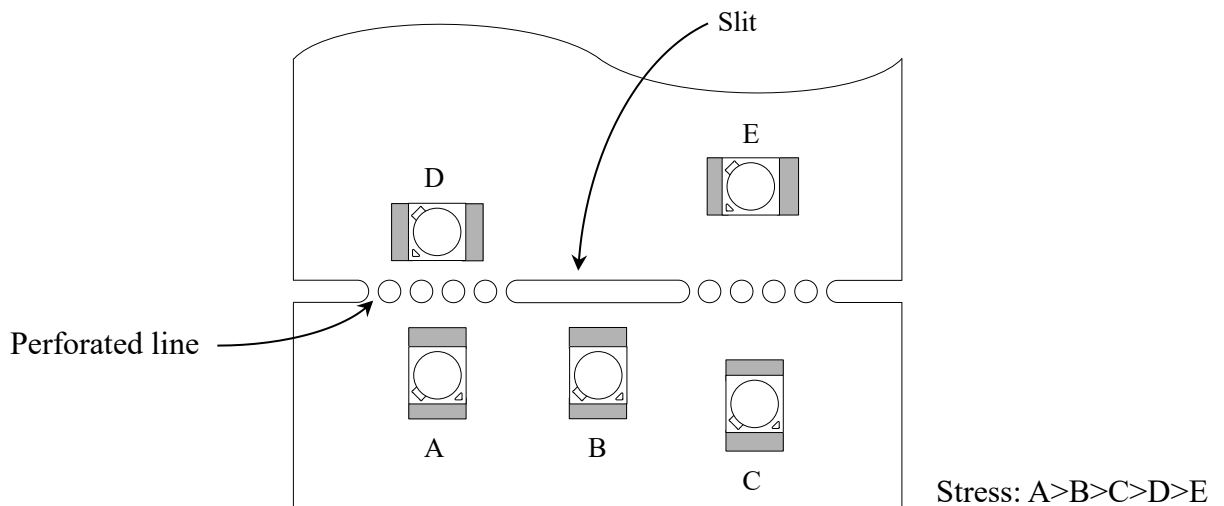

- The board should not be separated by hand but with the specified tool/machine.
- The solder can get cracked due to thermal stress during usage. Customers should verify the aluminum board in advance.

- Volatile organic compounds that have been released from materials present around the LEDs (e.g. housing, gasket/seal, adhesive, secondary lens, lens cover, grease, etc.) may adhere to the LED emitting surface. If the LEDs are being used in a hermetically/near-hermetically sealed environment, these volatile compounds can discolor after being exposed to heat and/or photon energy and it may greatly reduce the LED light output. In this case, ventilating the environment may improve the reduction in light output. Perform a light-up test of the chosen application for optical evaluation prior to use to ensure that there are no issues, this test should be performed taking into consideration the conditions/environments in which the end-product containing these LEDs will actually be used.

6. Electrostatic Discharge (ESD)

- LED products are sensitive to static electricity or surge voltage. ESD can damage LED chip, resulting in degradation of the reliability performance. When handling the LED products, necessary precautions should be taken including the following:
 - To eliminate static charge by using wrist straps, conductive garment/shoes/floor mats, etc.
 - To eliminate static charge by grounding machines and tools in workplaces,
 - To set work bench, stocks, floors made from conductive materials.
- Customers should protect the machines, tools, and devices against surge voltage by grounding them.
- Customers should take necessary measures when using insulating materials such as glass and plastic for the tools and machines. For example,
 - To dissipate static charge with conductive materials
 - To prevent static buildup by humidification
 - To neutralize electric charge with ionizers
- During the characteristics measurement of the LED-assembled product, customers are advised to confirm whether the LEDs are damaged by ESD. The damaged LEDs can be detected by measuring the forward voltage when low electrical current (1 mA or less; recommended) is applied to them.

The turn-on voltage in the forward direction will be decreased in the ESD-damaged LEDs.

The criterion should be: $V_F < 2.0V$ at $I_F = 0.5mA$

The above criterion is for typical LED models. It will vary depending on specific LED models. Customers should refer to the specifications for the criterion.

7. Thermal Management

- Proper thermal management is necessary when using LED products. Temperature elevation of the LED die varies depending on the board's heat resistance and the LEDs' pitch. Customers should design the LED products with a good heat dissipation system so as not to exceed the maximum junction temperature (T_J max) due to the surrounding conditions.
- The drive current should be determined based on the ambient temperature (T_A) to design the heat dissipation performance of the LED products.

8. Cleaning

8-1. For products using glass for sealing covers/lenses

- Do not clean the LEDs. If the LED is cleaned, it may cause damage to the LED causing issues; ensure that if the LEDs are cleaned, sufficient verification is performed prior to use. Additionally, ensure that the solvent being used does not cause any other issues.※¹
- Refrain from ultrasonic cleaning. If necessary, customers should confirm whether ultrasonic cleaning will affect the LEDs installed in the final product, since the LEDs can be affected depending on the ultrasonic power and the board installation method.

8-2. For products using resin for sealing covers/lenses

- Do not clean the LEDs with a wet cloth, benzoin, thinner, etc.
- Isopropyl alcohol (IPA) should be used if cleaning is required. Other cleaning agents may affect the LED package and resin, resulting in failure. Customers should evaluate them prior to use.※¹
- If an LED is contaminated (e.g. dust/dirt), use a cloth soaked with isopropyl alcohol (IPA). Ensure that the cloth is firmly squeeze before wiping the LED. If the LED uses a silicone resin for the lens; the silicone resin is soft. If pressure is applied to the resin lens, it may cause the resin lens to be damaged, chipped, and/or delaminated. If the resin is damaged, chipped, delaminated and/or deformed, it may cause the internal connection to fail causing a catastrophic failure (i.e. the LED not to illuminate).
- Refrain from ultrasonic cleaning. If necessary, customers should confirm whether ultrasonic cleaning will affect the LEDs installed in the final product, since the LEDs can be affected depending on the ultrasonic power and the board installation method.

9. Eye Safety

- There may be two important international specifications that should be noted for safe use of the LEDs: IEC 62471:2006 Photobiological safety of lamps and lamp systems and IEC 60825-1:2001 (i.e. Edition 1.2) Safety of Laser Products - Part 1: Equipment Classification and Requirements. Ensure that when using the LEDs, there are no issues with the following points:
 - LEDs have been removed from the scope of IEC 60825-1 since IEC 60825-1:2007 (i.e. Edition 2.0) was published. However, depending on the country/region, there are cases where the requirements of the IEC 60825-1:2001 specifications or equivalent must be adhered to.
 - LEDs have been included in the scope of IEC 62471:2006 since the release of the specification in 2006.
 - Most Nichia LEDs will be classified as the Exempt Group or Risk Group 1 according to IEC 62471:2006. However, in the case of high-power LEDs containing blue wavelengths in the emission spectrum, there are LEDs that will be classified as Risk Group 2 depending on the characteristics (e.g. radiation flux, emission spectrum, directivity, etc.)
 - If the LED is used in a manner that produces an increased output or with an optic to collimate the light from the LED, it may cause damage to the human eye.

※¹ Please be advised that the use of fluorocarbon solvent is strictly regulated worldwide.

- If an LED is operated in a manner that emits a flashing light, it may cause health issues (e.g. visual stimuli causing eye discomfort). The system should be designed to ensure that there are no harmful effects on the human body.
- This LED emits light in the ultraviolet (UV) region. The UV light from an LED while in operation is intense and harmful; if human eyes are exposed to this light, it may cause damage to them. Do not look directly or indirectly (e.g. through an optic) at the UV light. Ensure that if there is a possibility that the UV light reflects off objects and enters the eyes, appropriate protection gear (e.g. goggles) is used to prevent the eyes from being exposed to the light.
- Ensure that appropriate warning signs/labels are provided both on each of the systems/applications using the UV LEDs, in all necessary documents (e.g. specification, manual, catalogs, etc.), and on the packaging materials.

10. Others

- This LED is intended to be used for general lighting, household appliances, electronic devices (e.g. mobile communication devices); it is not designed or manufactured for use in applications that require safety critical functions (e.g. aircraft, automobiles, combustion equipment, life support systems, nuclear reactor control system, safety devices, spacecraft, submarine repeaters, traffic control equipment, trains, vessels, etc.). If the LEDs are planned to be used for these applications, unless otherwise detailed in the specification, Nichia will neither guarantee that the LED is fit for that purpose nor be responsible for any resulting property damage, injuries and/or loss of life/health. This LED does not comply with IATF 16949 and is not intended for automotive applications.
- Customers shall not reverse engineer, disassemble, or analyze the LEDs prior to having a written consent from Nichia. When defective LEDs are found, customers are required to directly inform Nichia before disassembling or analyzing them.
- This application note contains general information described by the LEDs' specifications. Make sure to obtain the latest specifications and to confirm the contents before using the LEDs.

Disclaimer

This application note is a controlled document of Nichia Corporation (Nichia) published to provide technical information/data for reference purposes only. By using this application note, the user agrees to the following:

- This application note has been prepared solely for reference on the subject matters incorporated within it and Nichia makes no guarantee that customers will see the same results for their chosen application.
- The information/data contained herein are only typical examples of performances and/or applications for the product. Nichia does not provide any guarantees or grant any license under or immunity from any intellectual property rights or other rights held by Nichia or third parties.
- Nichia makes no representation or warranty, express or implied, as to the accuracy, completeness or usefulness of any information contained herein. In addition, Nichia shall not be liable for any damages or losses arising out of exploiting, using, or downloading or otherwise this document, or any other acts associated with this document.
- The content of this application note may be changed without any prior or subsequent notice.
- Copyrights and all other rights regarding the content of this document are reserved by Nichia or the right holders who have permitted Nichia to use the content. Without prior written consent of Nichia, republication, reproduction, and/or redistribution of the content of this document in any form or by any means, whether in whole or in part, including modifications or derivative works hereof, is strictly prohibited.